



SMD LED

Product Data Sheet

LTW-006DCG-5

Spec No.: DS22-2010-0293

Effective Date: 11/30/2010

Revision: -

LITE-ON DCC

RELEASE

BNS-OD-FC001/A4

Property of Lite-On Only

Features

- * Package in 12mm tape on 7" diameter reels.
- * Compatible with automatic placement equipment.
- * Compatible with infrared and vapor phase reflow solder process.
- * EIA STD package.
- * I.C. compatible.
- * Meet green product and Pb-free(According to RoHS)



Package Dimensions

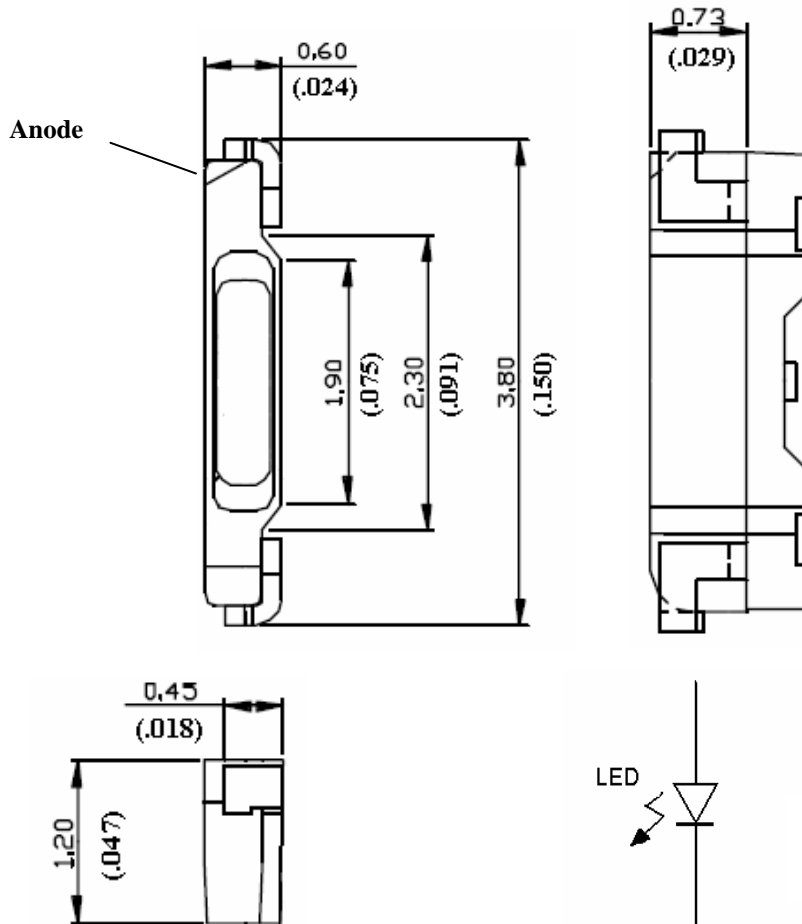

| Part No. | Lens Color | Source Color |
|--------------|------------|--------------|
| LTW-006DCG-5 | Yellow | InGaN White |

Notes:

1. All dimensions are in millimeters (inches).
2. Tolerance is ± 0.1 mm (.004") unless otherwise noted.

Property of Lite-On Only

Absolute Maximum Ratings at Ta=25°C

| Parameter | LTW-006DCG-5 | Unit |
|--|----------------------|------|
| Power Dissipation | 120 | mW |
| Peak Forward Current (1/10 Duty Cycle, 0.1ms Pulse Width) | 100 | mA |
| DC Forward Current | 30 | mA |
| Reverse Voltage | 5 | V |
| Operating Temperature Range | -30°C to +85°C | |
| Storage Temperature Range | -40°C to +100°C | |
| Reflow Soldering Condition | 260°C For 10 Seconds | |

Note: Operating the LED (in an application) under reverse bias condition might result in damage or failure of the component.

Suggest IR Reflow Condition :

R-Reflow Soldering Profile for lead free soldering (Acc. to J-STD-020D)

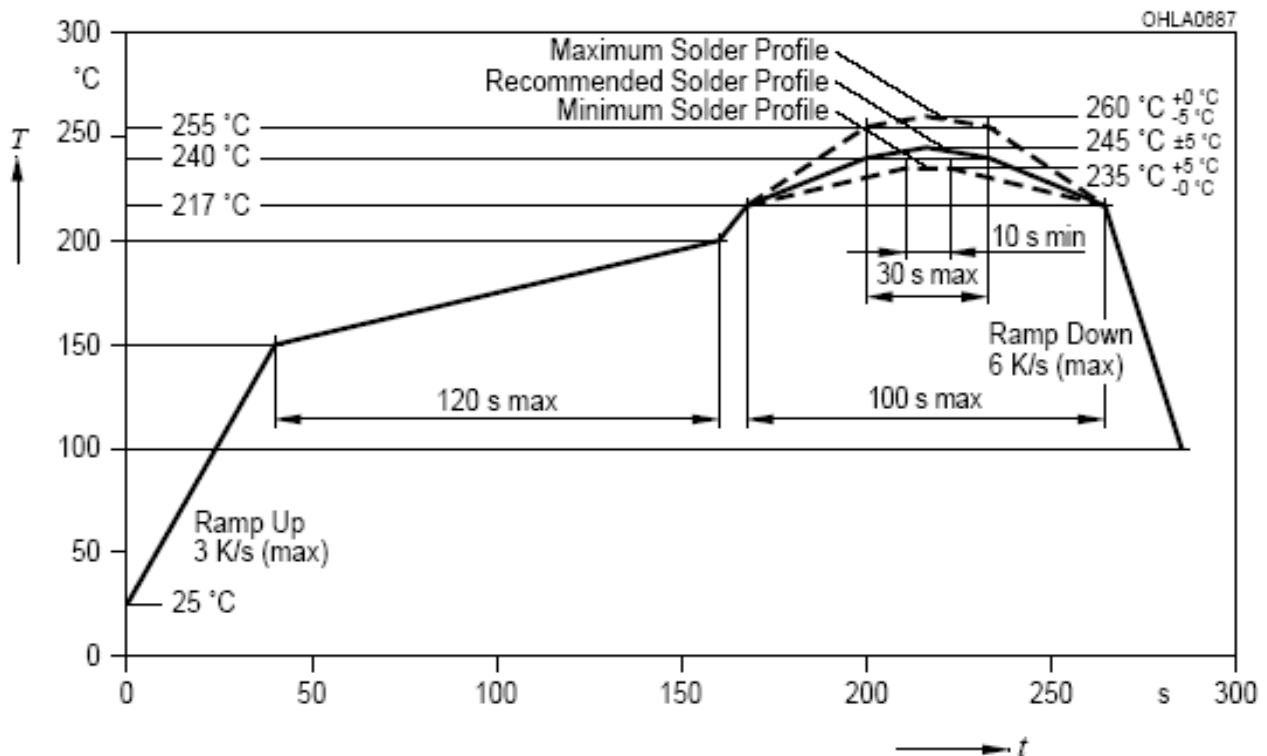

Property of Lite-On Only

Electrical Optical Characteristics At Ta=25°C

| Parameter | Symbol | Part No. LTW- | Min. | Typ. | Max. | Unit | Test Condition |
|--------------------------|---------------|------------------|------|-------|------|------|--------------------------------|
| Luminous Intensity | IV | 006DCG-5 | 450 | | 750 | mcd | IF = 5mA Note 1, 2, 5 |
| Viewing Angle | 2θ 1/2 | 006DCG-5 | | 110 | | deg | Fig.6 |
| Chromaticity Coordinates | x | 006DCG-5 | | 0.277 | | | IF = 5mA Note 3, 5 Fig.1 |
| | y | | | 0.255 | | | |
| Forward Voltage | VF | 006DCG-5 | 2.65 | | 3.25 | V | IF = 5mA |
| ESD-Withstand Voltage | ESD | 006DCG-5 | 200 | | | V | HBM |

Note : 1. Luminous intensity is measured with a light sensor and filter combination that approximates the CIE eye-response curve.

2. Iv classification code is marked on each packing bag.

3. The chromaticity coordinates (x, y) is derived from the 1931 CIE chromaticity diagram.

4. Caution in ESD:

Static Electricity and surge damages the LED. It is recommend to use a wrist band or anti-E2lectrostatic glove when handling the LED. All devices, equipment and machinery must be properly grounded.

5. CAS140B is the test standard for the chromaticity coordinates (x, y) & IV.

6. The chromaticity coordinates (x, y) guarantee should be added +/- 0.007 tolerance.

Property of Lite-On Only

Bin Code List

| VF Spec. Table | | |
|-----------------------|--|-------------|
| VF Bin | Forward Voltage (V) at IF = 5mA | |
| | Min. | Max. |
| V0 | 2.65 | 2.75 |
| V1 | 2.75 | 2.85 |
| V2 | 2.85 | 2.95 |
| V3 | 2.95 | 3.05 |
| V4 | 3.05 | 3.15 |
| V5 | 3.15 | 3.25 |
| V6 | | |

Tolerance on each Forward Voltage bin is +/-0.10 volt

| IV Spec. Table | | |
|-----------------------|---|-------------|
| IV Bin | Luminous Intensity (mcd) at IF = 5mA | |
| | Min. | Max. |
| S41 | 450 | 500 |
| S42 | 500 | 550 |
| S51 | 550 | 600 |
| S52 | 600 | 650 |
| S61 | 650 | 700 |
| S62 | 700 | 750 |
| S71 | 750 | 800 |
| S72 | 800 | 850 |
| S81 | 850 | 900 |
| S82 | 900 | 950 |

Tolerance on each Luminous Intensity bin is +/- 7%.

Property of Lite-On Only

| Color Ranks Table | | | | | |
|-------------------|-----------------------------------|-------|-------|-------|-------|
| Ranks | Color bin limits at IF = 5mA | | | | |
| | CIE 1931 Chromaticity coordinates | | | | |
| C12 | x | 0.265 | 0.27 | 0.27 | 0.265 |
| | y | 0.237 | 0.245 | 0.258 | 0.25 |
| C21 | x | 0.27 | 0.275 | 0.275 | 0.27 |
| | y | 0.245 | 0.253 | 0.266 | 0.258 |
| C22 | x | 0.275 | 0.28 | 0.28 | 0.275 |
| | y | 0.253 | 0.261 | 0.274 | 0.266 |
| C31 | x | 0.28 | 0.285 | 0.285 | 0.28 |
| | y | 0.261 | 0.269 | 0.282 | 0.274 |
| C32 | x | 0.285 | 0.29 | 0.29 | 0.285 |
| | y | 0.269 | 0.277 | 0.29 | 0.282 |
| B12 | x | 0.265 | 0.27 | 0.27 | 0.265 |
| | y | 0.224 | 0.232 | 0.245 | 0.237 |
| B21 | x | 0.27 | 0.275 | 0.275 | 0.27 |
| | y | 0.232 | 0.24 | 0.253 | 0.245 |
| B22 | x | 0.275 | 0.28 | 0.28 | 0.275 |
| | y | 0.24 | 0.248 | 0.261 | 0.253 |
| B31 | x | 0.28 | 0.285 | 0.285 | 0.28 |
| | y | 0.248 | 0.256 | 0.269 | 0.261 |
| B32 | x | 0.285 | 0.29 | 0.29 | 0.285 |
| | y | 0.256 | 0.264 | 0.277 | 0.269 |

Tolerance on each Hue (x, y) bin is +/- 0.007.

C. I. E. 1931 Chromaticity Diagram @5mA

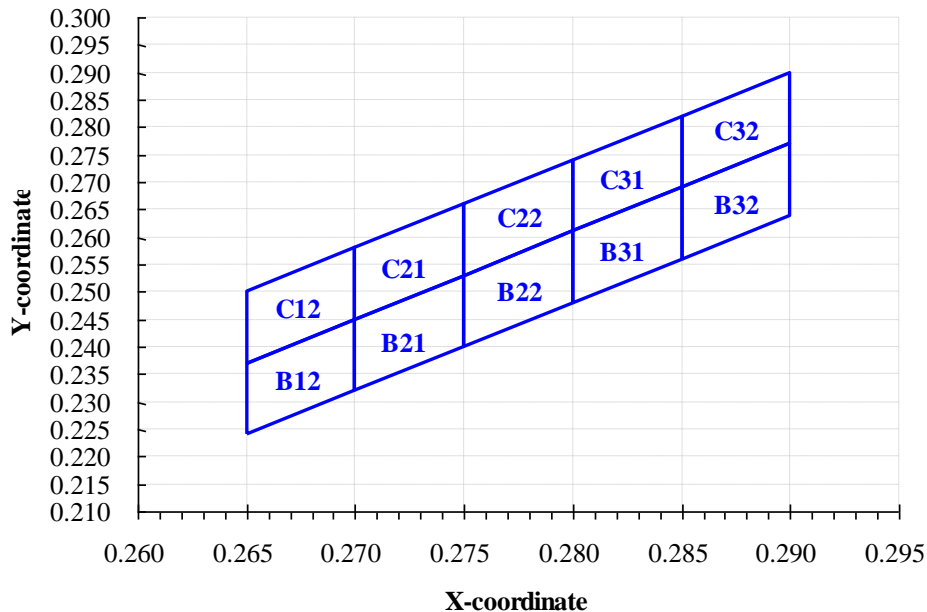

Property of Lite-On Only

Typical Electrical / Optical Characteristics Curves (25°C Ambient Temperature Unless Otherwise Noted)

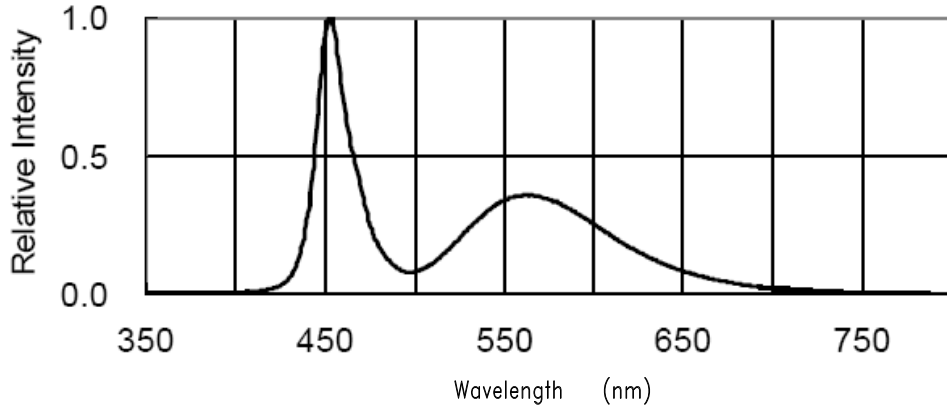

Fig.1 RELATIVE INTENSITY VS. WAVELENGTH

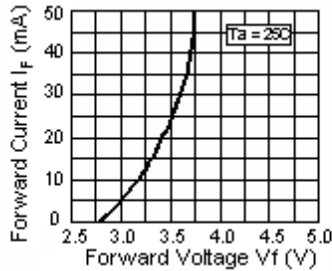

Fig.2 Forward Current vs. Forward Voltage

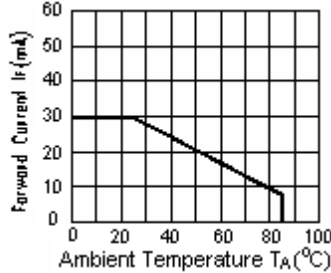

Fig.3 Forward Current Derating Curve

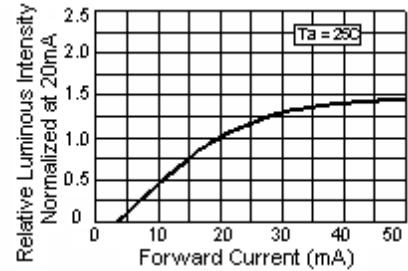

Fig.4 Relative Luminous Intensity vs. Forward Current

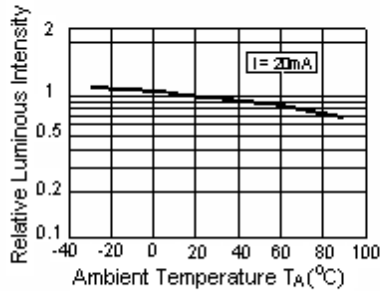

Fig.5 Luminous Intensity vs. Ambient Temperature

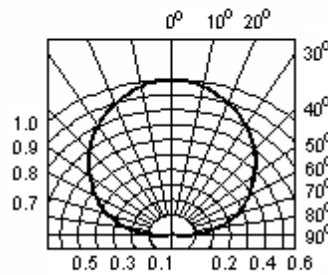

Fig.6 Spatial Distribution

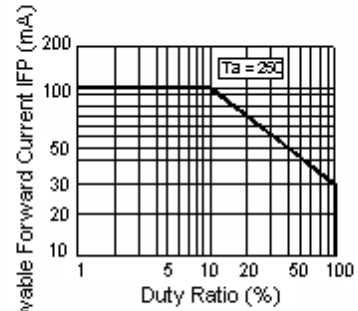

Fig.7 Duty Ratio vs. Allowable Forward Current

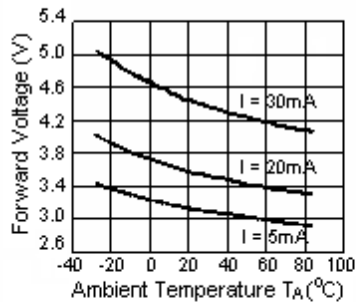

Fig.8 Ambient Temperature vs. Forward Voltage

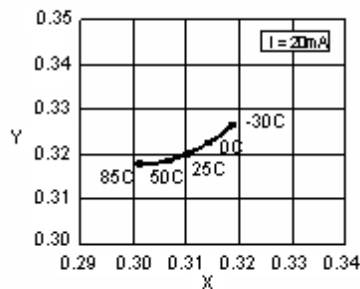

Fig.9 Ambient Temperature vs. Chromaticity Coordinate

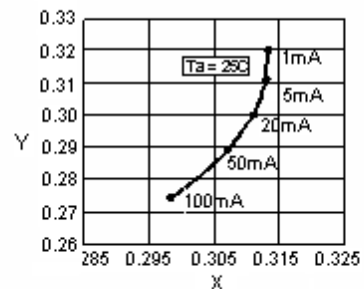
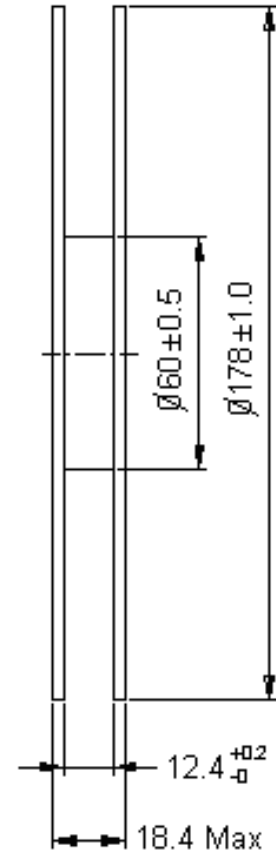
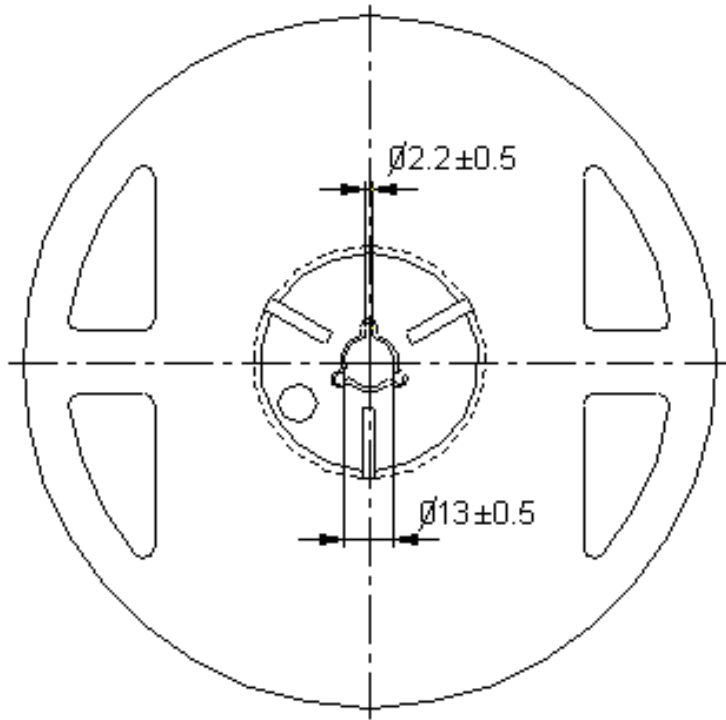

Fig.10 Forward Current vs. Chromaticity Coordinate

Property of Lite-On Only

Package Dimensions of Reel



Note: 01. The tolerance unless mentioned is ± 0.1 mm
02. The measured unit is "mm"

Notes:

1. Empty component pockets sealed with top cover tape.
2. 7 inch reel-2000 pieces per reel.
3. The maximum number of consecutive missing lamps is two.
4. In accordance with EIA-481-1-E2 specifications.

CAUTIONS

1. Application

The LEDs described here are intended to be used for ordinary electronic equipment (such as office equipment, communication equipment and household applications). Consult Liteon's Sales in advance for information on applications in which exceptional reliability is required, particularly when the failure or malfunction of the LEDs may directly jeopardize life or health (such as in aviation, transportation, traffic control equipment, medical and life support systems and safety devices).

2. Storage

This product is qualified as Moisture sensitive Level 3 per JEDEC J-STD-020 Precaution when handling this moisture sensitive product is important to ensure the reliability of the product.

The package is sealed:

The LEDs should be stored at 30°C or less and 90%RH or less. And the LEDs are limited to use within one year, while the LEDs is packed in moisture-proof package with the desiccants inside.

The package is opened:

The LEDs should be stored at 30°C or less and 60%RH or less. Moreover, the LEDs are limited to solder process within 168hrs. If the Humidity Indicator shows the pink color in 10% even higher or exceed the storage limiting time since opened, that we recommended to baking LEDs at 60°C at least 48hrs. To seal the remainder LEDs return to package, it's recommended to be with workable desiccants in original package.

3. Cleaning

Use alcohol-based cleaning solvents such as isopropyl alcohol to clean the LED if necessary.

4. Soldering

Recommended soldering conditions:

| Reflow soldering | | Soldering iron | |
|------------------|---------------|----------------|-----------------|
| Pre-heat | 120~150°C | Temperature | 300°C Max. |
| Pre-heat time | 120 sec. Max. | Soldering time | 3 sec. Max. |
| Peak temperature | 260°C Max. | | (one time only) |
| Soldering time | 30 sec. Max. | | |

5. Drive Method

An LED is a current-operated device. In order to ensure intensity uniformity on multiple LEDs connected in parallel in an application, it is recommended that a current limiting resistor be incorporated in the drive circuit, in series with each LED as shown in Circuit A below.

Circuit model A

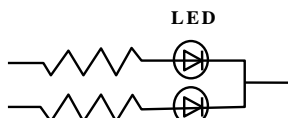

(A) Recommended circuit.

Circuit model B

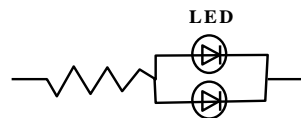

(B) The brightness of each LED might appear different due to the differences in the I-V characteristics of those LEDs.

Property of Lite-On Only

6. ESD (Electrostatic Discharge)

Static Electricity or power surge will damage the LED. Suggestions to prevent ESD damage:

- Use of a conductive wrist band or anti-Electrostatic glove when handling these LEDs.
- All devices, equipment, and machinery must be properly grounded.
- Work tables, storage racks, etc. should be properly grounded.
- Use ion blower to neutralize the static charge which might have built up on surface of the LED's plastic lens as a result of friction between LEDs during storage and handling.

ESD-damaged LEDs will exhibit abnormal characteristics such as high reverse leakage current, low forward voltage, or “ no lightup ” at low currents.

To verify for ESD damage, check for “ lightup ” and Vf of the suspect LEDs at low currents.

The Vf of “ good ” LEDs should be $>2.0V@0.1mA$ for InGaN product

7.1 Reliability Test

| Test Item | Test Condition | Reference Standard | Note | Number of Damaged |
|---|--|--------------------------|--------------------|-------------------|
| Resistance to Soldering Heat (Reflow Soldering) | Tsld=260°C, 10sec. | JEITA ED-4701 300 301 | 2 times | 0/50 |
| Solderability (Reflow Soldering) | Tsld=245±5°C, 3sec. (Lead Free Solder) | JEITA ED-4701 300 303 | 1 time Over 95% | 0/50 |
| Thermal Shock | -30°C ~ 85°C 30min. 30min. | JEITA ED-4701 300 307 | 100 cycles | 0/50 |
| Temperature Cycle | -40°C ~ 25°C ~ 100°C ~ 25°C 30min. 5min. 30min. 5min. | JEITA ED-4701 100 105 | 100 cycles | 0/50 |
| High Temperature Storage | Ta=100°C | JEITA ED-4701 200 201 | 1000 hrs. | 0/50 |
| Temperature Humidity Storage | Ta=60°C, RH=90% | JEITA ED-4701 100 103 | 1000 hrs. | 0/50 |
| Low Temperature Storage | Ta=-40°C | JEITA ED-4701 200 202 | 1000 hrs. | 0/50 |
| Steady State Operating Life Condition 1 | Ta=25°C, IF=20mA | | 1000 hrs. | 0/50 |
| Steady State Operating Life Condition 2 | Ta=25°C, IF=30mA | | 500 hrs. | 0/50 |
| Steady State Operating Life of High Temperature | Ta=85°C, IF=5mA | | 1000 hrs. | 0/50 |
| Steady State Operating Life of High Humidity Heat | 60°C, RH=90%, IF=15mA | | 500 hrs. | 0/50 |
| Steady State Operating Life of low Temperature | Ta=-30°C, IF=20mA | | 1000 hrs. | 0/50 |

7.2 Criteria for Judging the Damage

| Item | Symbol | Test Conditions | Criteria for Judgment | |
|--------------------|--------|-----------------|-----------------------|----------------|
| | | | Min. | Max. |
| Forward Voltage | VF | IF=20mA | - | U.S.L.*) × 1.1 |
| Luminous Intensity | IV | IF=20mA | U.S.L.***) × 0.7 | - |

8. Others

The appearance and specifications of the product may be modified for improvement without prior notice.

9. Suggested Checking List

Training and Certification

1. Everyone working in a static-safe area is ESD-certified?
2. Training records kept and re-certification dates monitored?

Static-Safe Workstation & Work Areas

1. Static-safe workstation or work-E2reas have ESD signs?
2. All surfaces and objects at all static-safe workstation and within 1 ft measure less than 100V?
3. All ionizer activated, positioned towards the units?
4. Each work surface mats grounding is good?

Personnel Grounding

1. Every person (including visitors) handling ESD sensitive (ESDS) items wear wrist strap, heel strap or conductive shoes with conductive flooring?
2. If conductive footwear used, conductive flooring also present where operator stand or walk?
3. Garments, hairs or anything closer than 1 ft to ESD items measure less than 100V*?
4. Every wrist strap or heel strap/conductive shoes checked daily and result recorded for all DLs?
5. All wrist strap or heel strap checkers calibration up to date?

Note: *50V for Blue LED.

Device Handling

1. Every ESDS items identified by EIA-471 labels on item or packaging?
2. All ESDS items completely inside properly closed static-shielding containers when not at static-safe workstation?
3. No static charge generators (e.g. plastics) inside shielding containers with ESDS items?
4. All flexible conductive and dissipative package materials inspected before reuse or recycle?

Others

1. Audit result reported to entity ESD control coordinator?
2. Corrective action from previous audits completed?
3. Are audit records complete and on file?